

JAN/FEB 1989

ISSUE # 27

VZ 200/300

HUNTER VALLEY

VZ JOURNAL

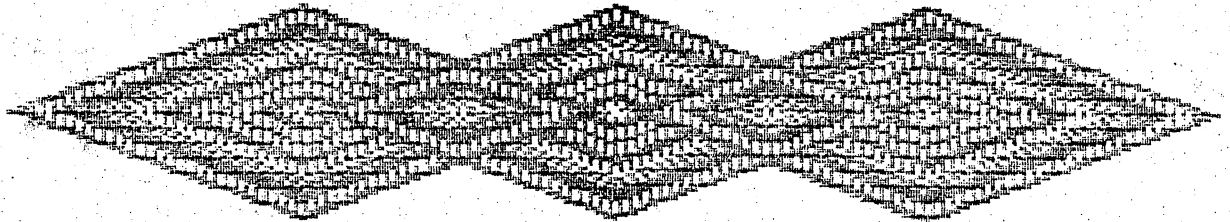
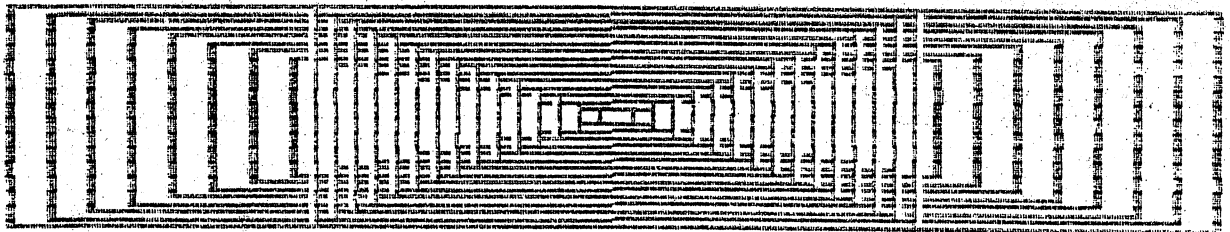
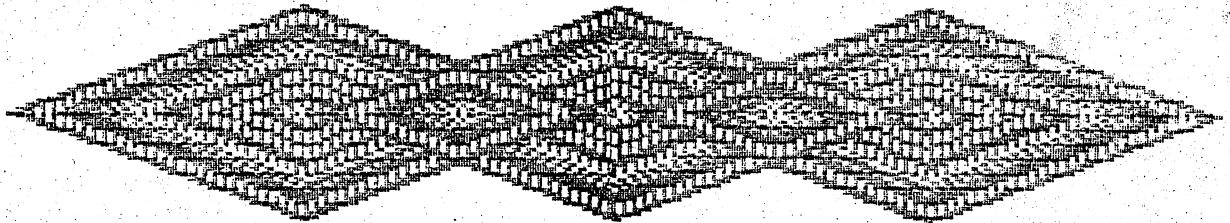

PRODUCED BI-MONTHLY BY H.V.VZ.U.G.

# EDITOR'S COMMENTS ISSUE # 22 . .

THIS PUBLICATION WAS PREPARED USING DAVE MITCHELL'S PATCH3.3 TOGETHER WITH E & F WORD PROCESSOR. HI & LO-RES SCREEN DUMPS AND LISTINGS WERE DONE USING LARRY TAYLOR'S PRINTER PATCH V1.4 AVAILABLE FROM VSOFTWAREZ AND A STAR NX1000 PRINTER WAS USED. PATCH 3.3 IS AVAILABLE FROM HUNTER VALLEY VZ USERS' GROUP.

CLUB NEWS/NEXT MEETING/ETC . . . . . PAGE 3

THE VZ - WHERE TO FROM HERE BY LARRY TAYLOR . . . . . PAGES 4-5

SINCE THE DEMISE OF THE VZ MOST VZ USERS ARE'NT SURE WHETHER TO UPDATE TO ANOTHER COMPUTER SYSTEM OR STICK WITH THE VZ. LARRY'S TIMELY PERSONAL OPINION ON THE MATTER MIGHT JUST HELP CLEAR THINGS UP FOR YOU.

PRINTER CONTROL CODES BY EDDIE TOMES . . . . . PAGE 6-7

THE PROGRAM PRESENTED BY EDDIE IS DESIGNED TO HELP YOU WORK OUT YOUR PRINTER C/CODES BY SUBSTITUTING OR ADDING YOUR OWN.

HI-RESOLUTION DRAWER BY ROBERT QUINN . . . . . PAGES 8-10

THE BEAUTY OF THIS HI-RES DRAWING PROGRAM OVER COMMERCIAL ONES IS THAT IT CAN EASILY BE EXPANDED OR ADAPTED TO YOUR OWN NEEDS BY INCORPORATING YOUR OWN OR PREVIOUSLY PUBLISHED ROUTINES.

DISK DRIVE HEAD PARK ROUTINE BY DAVE MITCHELL . . . . . PAGES 11-12

BESIDES BEING ANNOYING THE RATTLE EMINATING FROM THE DRIVE ON POWER UP OR RESET CAN EVENTUALLY LEAD TO HEAD MISALIGNMENT. DAVE'S ROUTINE SHOULD GO A LONG WAY IN AVOIDING ABOVE PROBLEM.

HINTS & TIPS FOR DISK AND TAPE USERS . . . . . PAGE 12

PICT COPY - HI/LO-RES COPIER BY JOE LEON . . . . . PAGES 13-15

PICT COPY WILL ALLOW YOU TO COPY BOTH HI & LO-RES SCREENS FROM DISK TO DISK USING ONE OR TWO DRIVES OR COPY TO PRINTER. A SIMPLE PICTURE SLIDE SHOW IS PROVIDED AS WELL.

NOTE - LOAD IN OR ENTER DISK UTILITY FROM ISSUE # 21 FIRST

VZ200/300 8K S/WAYS RAM/SUPER GRAPHICS BY J.LEON . . . . . PAGES 16-19

IN APRIL 1988 ISSUE OF AUSTRALIAN ELECTRONICS MONTHLY AN ULTRA GRAPHICS ADAPTOR FOR VZ 200/300 WAS PUBLISHED BY MATTHEW SORELL. THE SUPER GRAPHICS ADAPTOR PRESENTED HERE IS EASIER TO CONSTRUCT AS IT'S MODULAR IN DESIGN AND ONLY USES 3 IC'S.

VZ USER GROUPS - FOR SALE - SCREEN ED . . . . . PAGE 19

FOR SALE - NEW PATCH3.3 - EXT.DOS - MENU/FILE COPIER . . . . . PAGE 20

## NEXT ISSUE :-

128K S/WAYS RAM PART III - 64K R/PACK COMPATIBLE - VZ200 IDEAS  
PICT COPY PART II - BLOCK MOVE ROUTINE  
8K S/WAYS RAM/SUPER GRAPHICS PART II - PROGRAMMING & VZ200 LAYOUT  
CUSTOMIZING E & F WORD PROCESSOR PRINTER MENU FOR TAPE USERS

## COMING ISSUES :-

ATARI TYPE JOYSTICK ADAPTOR FOR VZ 200/300 - EPROM ERASER  
128K S/WAYS RAM FOR 4000H-5FFFH RANGE (DOS AREA)  
AUTO START/STOP FOR DATASSETTES

SOME OF ABOVE PROJECTS HAVE BEEN UP AND RUNNING WHILE OTHERS AWAIT COMPLETION. CIRCUMSTANCES AND TIME WILL DICTATE IF AND WHEN AND WHAT ISSUE/S THEY GET PUBLISHED IN.

LETTERS TO THE EDITOR :-

BARRY R. KNIGHT - I HAVE TO SAY THANKS FOR A REALLY GOOD MAGAZINE. I DON'T THINK YOU COULD PACK MUCH MORE IN IT. I PERSONALLY HOPE THAT YOU CAN KEEP IT GOING FOR A LONG WHILE YET. THE SUPPLEMENTS - REAL GOOD ... NEED BOTH OF THEM.

MR. J.A. CORLETT - YOUR MAGAZINE IS THE BEST OF THE THREE I SUBSCRIBE TO, IN REGARD TO AMOUNT AND QUALITY OF CONTENT AND EASE OF READING.

---

THE ABOVE COMMENTS ARE TYPICAL OF THE MANY LETTERS I RECEIVE AND I THANK THEM FOR TAKING THE TROUBLE BY SENDING THEIR COMPLIMENTS, CRITICISMS AND SUGGESTIONS. IT SEEMS THE NLQ ORATOR PRINT STYLE USED IN LAST ISSUE WAS A BIG HIT BECAUSE OF ITS EASY READABILITY AND WILL BE USED WHEREVER POSSIBLE.

THE HUNTER VALLEY VZ JOURNAL BELONGS TO ALL ITS MEMBERS REGARDLESS OF GEOGRAPHY. I CANNOT PRODUCE IT ON MY OWN AND MY SINCEREST THANKS FOR YOUR CONTINUED SUPPORT VIA YOUR ARTICLES AND SUBSCRIPTIONS. MY S.O.S. TO MOST MEMBERS FOR ARTICLES WAS ANSWERED AND CAN BE SEEN IN THIS ISSUE WITH SOME LEFT OVER FOR NEXT. ONLY YOUR SUPPORT AND INVOLMENT WILL KEEP THE VZ, IT'S PUBLICATIONS AND USER GROUPS ALIVE AND GOING STRONG.

---

HUNTER VALLEY VZ USERS' GROUP CLUB MEETINGS :-

ALL MEMBERS AND THEIR FAMILIES, VISITORS AND ANY INTERESTED PERSONS REGARDLESS OF SEX OR AGE, WHETHER LOCAL, INTRASTATE OR INTERSTATE ARE WELCOME AT CLUB MEETINGS.

ADMITTANCE - A \$2.00 DOOR CHARGE APPLIES PER MEMBER, FAMILY, VISITOR. THE DOOR CHARGE FEE IS USED FOR HALL RENTAL. VISITORS CAN ATTEND AS MANY MEETINGS AS THEY LIKE WITHOUT HAVING TO JOIN.

NOTE - COPYING OF COPYRIGHT MATERIAL IS NOT ALLOWED AT MEETINGS.

---

NEXT MEETINGS OF HUNTER VALLEY VZ USERS' GROUP IN 1989  
FEBRUARY 3 - MARCH 3 - APRIL 7 - MAY 5 - JUNE 2

---

6TH ANNUAL NEWCASTLE MICROCOMPUTING EXHIBITION - APRIL 13-15  
THE HUNTER VALLEY VZ USERS' GROUP HAS BEEN INVITED TO PARTICIPATE AGAIN. HOPE TO SEE YOU THERE.

---

DISCLAIMER - EVERY EFFORT IS MADE TO ENSURE THE ACCURACY OF INFORMATION CONTAINED WITHIN BE IT GENERAL, TECHNICAL, PROGRAMMING, ETC. NO RESPONSIBILITY CAN BE ACCEPTED BY H.V.VZ.U.G. OR AUTHOR AS A RESULT OF APPLYING SUCH INFORMATION.

THE HUNTER VALLEY VZ JOURNAL IS SUBJECT TO COPYRIGHT AND NO MATERIAL IN THIS JOURNAL MAY BE REPRODUCED IN PART OR WHOLE WITHOUT THE CONSENT OF THE AUTHOR WHO RETAINS COPYRIGHT.

THE VZ - WHERE TO FROM HERE

VIDEO TECHNOLOGY HAS CEASED TO MANUFACTURE THE VZ, DICK SMITH ELECTRONICS NO LONGER SELL IT, THE GERMAN DIVISION OF SANYO HAVE NO FURTHER STOCKS. USER SUPPORT IS BEGINNING TO DWINDLE AS ONE BY ONE REALISTIC SOFTWARE AND MAGAZINE DISTRIBUTORS WITHDRAW THEIR PROGRAMS AND PUBLICATIONS. NO MORE VZEDS MEAN NO MORE NEW OWNERS TO BUY PROGRAMS, SUBSCRIBE TO MAGAZINES OR REPLACE FORMER VZ USERS WHO HEAD FOR GREENER PASTURES. IS THIS THE END OF THE VZ? THAT DEPENDS ON WHY YOU BOUGHT IT. IF YOU READ ON, I'LL GIVE YOU MY OPINION.

THE VZ WAS FIRST RELEASED IN APRIL 1983 (HAS IT REALLY BEEN SIX YEARS?), AT A TIME WHEN THE MARKET WAS BEING SWAMPED BY NUMEROUS HOME COMPUTERS. I LOOKED AT MANY OF THEM, INCLUDING THE ATARI 400, COMMODORE 64, SPECTRUM AND ORIC BEFORE FINALLY DECIDING ON THE VZ 200. AS A GAMES MACHINE, THE VZ STOOD NO CHANCE AGAINST ITS COMPETITORS, A QUICK COMPARISON OF THE GRAPHICS AND SOUND CAPABILITIES OF EACH WOULD CLEARLY DEMONSTRATE THAT, BUT AS A TOOL FOR LEARNING ABOUT COMPUTERS AND COMPUTING, ON EASE OF USE ALONE, I BELIEVE IT SURPASSES THEM ALL.

A FEW MONTHS BEFORE MY PURCHASE I KNEW NOTHING AT ALL ABOUT COMPUTERS. AFTER HOURS OF READING AND A SHORT BASIC PROGRAMMING COURSE, I KNEW ENOUGH TO GET STARTED. AS A PRIMARY SCHOOL TEACHER, I SAW THE EDUCATIONAL POTENTIAL OF COMPUTERS. SINCE D.S.E. OFFERED SO LITTLE OF ANY QUALITY IN THE WAY OF EDUCATIONAL SOFTWARE, I SET ABOUT ATTEMPTING TO WRITE MY OWN.

MY FIRST EFFORT CALLED "WORLD CAPITALS", A SIMPLE MATCHING ACTIVITY, WAS AN EMBARRASSING, UNDISCIPLINED TANGLE OF CODE, WHICH WAS CONSTANTLY CRASHED BY CHILDREN ENTERING UNEXPECTED INPUT. I LEARNED A LOT FROM THAT FIRST EXPERIENCE. MY AIM BECAME TO PRODUCE EFFICIENTLY WRITTEN, KIDPROOF PROGRAMS, WHICH MADE THE MOST OF THE VZ'S FACILITIES.

I FOLLOWED UP BY WRITING KEYBOARD, MEAT PIES, MATHS COUNTDOWN, COORDINATES, TOWER OF HANOI, BLOCK PUZZLER, SNERTLE, WORD MATCHING, NAME THE TOWNS, ESCAPE RIVER AND FACTORY AND WITH EACH PROGRAM I TRIED TO IMPROVE ON THOSE THAT HAD PRECEDED IT. EACH ATTEMPT TO PRODUCE A SUCCESSFUL PIECE OF SOFTWARE ADDED TO MY LEARNING EXPERIENCE.

DURING THIS PERIOD I REALISED I HAD TO COME TO GRIPS WITH ASSEMBLY LANGUAGE, IN ORDER TO GET THE BEST OUT OF THE VZ. THIS INVOLVED MORE READING AND MORE MISTAKES, BUT EVENTUALLY I WAS ABLE TO WRITE PROGRAMS LIKE FILESEARCH, COPYPROTECT, DISKGUARD AND THE VZ-EPSON PRINTER PATCH.

THE MORE I WROTE IN ASSEMBLER, THE EASIER IT WAS FOR ME TO UNDERSTAND THE ROM AND DOS ROUTINES, THAT MAKE THE VZ TICK. I BEGAN TO DEVELOP A CLEARER UNDERSTANDING OF HOW THE VZ FUNCTIONED, BY SEEING HOW SOFTWARE AND HARDWARE WERE LINKED. THIS REALISATION HAS INEVITABLY LED ME TO TAKING AN INTEREST IN THE HARDWARE, THE NUTS AND BOLTS OF THE VZ, DESPITE THE FACT, THAT AS A BEGINNER I HAD VOWED AND DETERMINED I WOULD NEVER WANT TO KNOW ABOUT THE COMPUTER'S INNARDS.

I'VE COME TO RECOGNIZE, HOWEVER, THAT IT'S JUST ONE MORE ASPECT OF WHAT'S INVOLVED IN GAINING A REAL UNDERSTANDING OF THE VZ IN PARTICULAR, AND COMPUTERS IN GENERAL. TO MY AMAZEMENT, I AM ACTUALLY TRYING TO LEARN ABOUT LOGIC CIRCUITS AND HOW PERIPHERAL DEVICES ARE INTERFACED TO A COMPUTER, INFORMATION WHICH PROVIDES BY FAR THE BEST MEANS TO EXPAND THE VZ'S PRESENT CAPABILITIES.

OTHERS HAVE LEARNED TOO. TIME AND INCREASED KNOWLEDGE HAVE ENABLED SOME OF THE VZ'S RESTRICTIVE SHACKLES TO BE THROWN OFF. EXTENDED BASICS HAVE BEEN PRODUCED, ANY PRINTER OR PLOTTER, PARALLEL OR SERIAL MAY BE USED WITH IT. WE HAVE EVEN SEEN IT INTERFACED TO SOUND AND SPEECH SYNTHESISERS, WHILST HARDWARE MODIFICATIONS HAVE UNLOCKED THE FULL CAPABILITIES OF THE VZ'S GRAPHICS CHIP AND MUCH MORE IS POSSIBLE.

BUT, DESPITE THESE ADVANCES, THE VZ STILL HAS ITS LIMITATIONS AND SOME DAY, FINANCES PERMITTING, I WILL UNDOUBTEDLY UPGRADE TO A MORE SOPHISTICATED COMPUTER SYSTEM WITH A 16 BIT OR 32 BIT PROCESSOR, A MEGABYTE OR MORE OF MEMORY, VERY HIGH RESOLUTION GRAPHICS AND ENHANCED COLOUR AND SOUND CAPABILITIES.

THAT I CAN EVEN CONSIDER THIS IS DUE TO MY EXPERIENCES WITH THE VZ, BUT WILL I ATTEMPT TO WRITE SOFTWARE TO DRIVE THIS MARVELLOUS NEW MACHINE? NOT LIKELY. WOULD I MAKE HARDWARE MODIFICATIONS TO IT, WHICH INVOLVE MORE THAN PLUGGING A DEVICE INTO A SLOT? DEFINATELY NOT, I WILL HAVE INVESTED TOO MUCH MONEY TO RISK IT. I'LL BE USING THOROUGHLY TESTED, COMMERCIALY PRODUCED SOFTWARE AND HARDWARE CREATED BY TEAMS OF COMPUTER SPECIALISTS, OVER MANY HUNDREDS OF HOURS (AND COMPLAINING LOUDLY AND LONG, IF THEY DON'T FUNCTION AS EXPECTED).

CAN I LEARN MUCH ABOUT THE COMPUTER THIS WAY? NOT REALLY, SINCE MOST OF MY TIME WILL BE SPENT COMING TO GRIPS WITH THE INCREASINGLY COMPLEX SOFTWARE AND PERIPHERALS. TAKING A QUICK GLANCE THROUGH THE TITLES OF THE LATEST COMPUTER REFERENCE BOOKS, WHICH LINE BOOKSTORE SHELVES, WILL READILY CONFIRM THIS TO BE THE CASE. (IT'S ALSO WORTH REMEMBERING, WHILST ON THIS POINT, THAT THE MAJOR EXPENSE ALWAYS OCCURS AFTER BUYING THE COMPUTER.)

IN THE EVENT THAT I MAKE MY PURCHASE, WHAT IS TO BECOME OF THE VZ? UNLIKE THE COMPUTER DESCRIBED PREVIOUSLY, THERE IS NO DOUBT THAT THE VZ WAS MARKETED WITH AN INCREDIBLY ATTRACTIVE PRICE TAG, BUT ON NO ACCOUNT SHOULD IT BE DISMISSED AS MERELY A TOY. IT HAS THE CAPABILITY TO PERFORM MOST OF THE FUNCTIONS OF OTHER COMPUTERS. THE MAJOR DIFFERENCE BEING, THAT THE MEANS TO DO IT EASILY HASN'T BEEN HANDED TO US ON A PLATE, WE HAVE TO WORK IT OUT FOR OURSELVES AND THEREIN LIES THE VZ'S GREATEST VALUE.

MOST USERS OF THE VZ, LIKE MYSELF, BEGAN KNOWING LITTLE OR NOTHING AND WE OWE THE VZ A TREMENDOUS DEBT FOR WHAT IT HAS TAUGHT US. I HAVE LEARNED COMPUTER TERMINOLOGY, BITS, BYTES, ROM, RAM, DOS AND I/O, MORE ABOUT MATHEMATICAL NUMBER SYSTEMS, BINARY AND HEXIDECIMAL, HOW TO READ AND WRITE IN TWO LANGUAGES BASIC AND ASSEMBLER AND AN ENORMOUS AMOUNT ABOUT THE FUNCTION AND OPERATION OF COMPUTERS.

THE VZ'S FUTURE VALUE LIES IN WHAT IT CAN STILL TEACH ME. EVEN WHEN I FINALLY UNDERSTAND IT COMPLETELY, AND WHO KNOWS HOW LONG THAT MAY TAKE, THERE WILL STILL MAY BE MANY UNTRIED POSSIBILITIES TO FIRE THE IMAGINATION. PERHAPS A HOUSE, WHERE LIGHTING, HEATING AND COOLING, BURGLAR ALARMS AND EVEN THE TELEPHONES ARE ALL MONITORED AND CONTROLLED BY THE HUMBLE VZ.

WHILE THE VZ'S CIRCUITS CONTINUE TO FUNCTION, I CANNOT SEE IT OUTLIVING ITS USEFULNESS. IT WILL CONTINUE TO EXPAND MY UNDERSTANDING OF HOW COMPUTERS WORK BY ALLOWING INVESTIGATION AND EXPERIMENTATION ON A SCALE I WOULDN'T CONTEMPLATE ON AN EXPENSIVE AND COMPLEX COMPUTER.

SO IF YOU ARE CONSIDERING CONSIGNING YOUR VZ TO A DUSTY CUPBOARD IN FAVOUR OF A SHINY, NEW TOY, YOU MAY AT THE VERY LEAST BE COMMITTING A GRAVE INJUSTICE AND AT WORST, BE DEPRIVING YOURSELF OF THE BEST AND CHEAPEST OPPORTUNITY TO INCREASE YOUR KNOWLEDGE ABOUT COMPUTERS YOU'RE EVER LIKELY TO HAVE.



PRINTER CODES CONT. . . . . 7

```

295 :
300 LPRINTCHR$(14);:LPRINTC$:LPRINTCHR$(20);:GOTO 100
305 LPRINTCHR$(15);:LPRINTC$:LPRINTCHR$(18);:GOTO 100
310 LPRINTCHR$(27);"E";:LPRINTC$:LPRINTCHR$(27);"F";:GOTO 100
315 LPRINTCHR$(27);"G";:LPRINTC$:LPRINTCHR$(27);"H";:GOTO 100
320 LPRINTCHR$(27);"M";:LPRINTC$:LPRINTCHR$(27);"P";:GOTO 100
325 LPRINTCHR$(27);"4";:LPRINTC$:LPRINTCHR$(27);"5";:GOTO 100
330 LPRINTCHR$(27);"-";CHR$(1);:LPRINTC$
335 LPRINTCHR$(27);"-";CHR$(0);:GOTO 100
340 LPRINTCHR$(27);"S";CHR$(1);:LPRINTC$
345 LPRINTCHR$(27);"T";:GOTO 100
350 LPRINTCHR$(27);"S";CHR$(0);:LPRINTC$
355 LPRINTCHR$(27);"T";:GOTO 100
360 LPRINTCHR$(15);:LPRINTCHR$(27);"S";CHR$(1);:LPRINTC$
365 LPRINTCHR$(18);:LPRINTCHR$(27);"T";:GOTO 100
370 LPRINTCHR$(15);:LPRINTCHR$(27);"S";CHR$(0);:LPRINTC$
375 LPRINTCHR$(18);:LPRINTCHR$(27);"T";:GOTO 100
495 :
500 CLS:PRINT PC$:PRINT
505 PRINT"      IF YOU ARE USING AN EPSON"
510 PRINT" COMPATIBLE PRINTER THEN YOU"
515 PRINT" NEED TO LOAD THE PRINTER PATCH"
520 PRINT" FIRST TO OBTAIN FULL CONTROL"
525 PRINT" OF PRINTER MODES INCLUDING"
530 PRINT" INVERSE AND GRAPHICS AS WELL .":PRINT:PRINT
535 PRINT"      IF PRINTER PATCH NOT LOADED"
540 PRINT" IN THEN RECOMMENCE BY LOADING"
545 PRINT" THIS UTILITY FIRST PLEASE ."
550 :
560 FOR N=1 TO 3000:NEXT N
570 SOUND1,1:PRINT:END

```

THE ABOVE PROGRAM SUBMITTED BY EDDIE IS ONLY A GUIDE ON HOW THE PRINTER CONTROL CODES CAN BE USED IN DIRECT MODE OR FROM WITHIN A PROGRAM. THE CODES SHOWN MAY NOT WORK WITH YOUR PARTICULAR PRINTER. THE IDEA IS FOR YOU TO TRY YOUR OWN CODES BY SUBSTITUTING ONES PRESENTED. ALTERNATIVELY YOU COULD ENLARGE PROGRAM BY ADDING ADDITIONAL CODE MENUES FROM WHICH TO CHOSE.

THE EPSON PRINTER PATCH STRICTLY SPEAKING IS ONLY NEEDED FOR INVERSE AND GRAPHIC CHARACTERS AND OTHER SPECIAL COMMANDS LIKE PAGE, FEED, LTAB(0), ETC. IT'S EASIER TO HAVE IT LOADED IN FIRST THAN HAVING TO RELOAD BOTH PATCH AND YOUR PROGRAM.

BELOW THE TWO SCREEN DUMPS ON PAGE 6 ARE SAMPLE PRINTOUTS USING ALL OPTIONS SHOWN IN MENU. AS MENTIONED BEFORE THERE WOULD BE MANY MORE OPTIONS AVAILABLE ON MOST PRINTERS. WHEN USING PRINTER CODES THERE IS ONE IMPORTANT POINT TO REMEMBER AND THAT IS NOT TO FORGET TO TURN PARTICULAR FUNCTION OFF AFTER IT'S USE IS NO LONGER REQUIRED. WE'LL TAKE UNDERLINE AS AN EXAMPLE IN LINES 330 & 335 :-

```

LPRINT CHR$(27);"-";CHR$(1) - TURNS UNDERLINE ON
LPRINT C$                    - PRINTS TEXT TO PRINTER
LPRINT CHR$(27);"-";CHR$(0) - TURNS UNDERLINE OFF

```

MANY PAGES COULD BE FILLED ON HOW TO USE YOUR PRINTER, BUT THE BEST WAY TO LEARN IS FOR YOU TO TRY AND TRY AGAIN IF AT FIRST YOU DON'T SUCCEED, IT'S UP TO YOU NOW.

HIDRAWER IS A MODE(1) GRAPHICS SKETCHER PROGRAM.

WHEN RUN, A FLASHING POINT--THE PEN--APPEARS AT CENTER OF SCREEN. THE INITIAL BACKGROUND COLOUR IS GREEN; THE DRAWING COLOUR IS BLUE.

<N> SWITCHES BACKGROUND COLOUR BETWEEN GREEN AND BUFF.

<Q>, <W>, <E> AND <R> SELECT GREEN, YELLOW, BLUE AND RED FOR DRAWING COLOUR. NOTE THESE KEYS ARE LOCATED UNDER NUMBER KEYS <1> TO <4>, WHICH ARE THE NUMBERS OF THE RESPECTIVE FOREGROUND COLOURS. THE NUMBER KEYS WERE NOT USED THEMSELVES FOR COLOUR SELECTION BECAUSE THEY SERVE ANOTHER FUNCTION.

<Q> SELECTS GREEN DRAWING COLOUR.  
<W> SELECTS YELLOW DRAWING COLOUR.  
<E> SELECTS BLUE DRAWING COLOUR.  
<R> SELECTS RED DRAWING COLOUR.

<TO DRAW> PRESS & HOLD DOWN CURSOR CONTROL KEYS, WITHOUT <CTRL>.

<M> MOVES PEN LEFT.  
<,> MOVES PEN RIGHT.  
<.> MOVES PEN UP.  
< > MOVES PEN DOWN.

WHEN PEN REACHES SCREEN BORDER, IT WILL CONTINUE TO MOVE IN SAME DIRECTION FROM OPPOSITE SIDE OF SCREEN.

INITIALLY HIDRAWER IS IN DRAW MODE.

<: > SWITCHES BETWEEN DRAW AND KEEP.

IN KEEP MODE, THE PEN CAN BE MOVED ABOUT THE SCREEN WITHOUT DRAWING AND WITHOUT ERASING. IF YOU WANT TO ERASE LINES (TO THE BACKGROUND COLOUR) THEN USE <Q> TO SELECT GREEN AND MOVE PEN IN DRAW MODE OVER LINES YOU WANT RID OF.

HIDRAWER BEGINS IN CONTINUOUS MODE, IN WHICH THE PEN MOVES CONTINUOUSLY AS YOU HOLD DOWN THE CONTROL KEYS AND STOPS IMMEDIATELY YOU RELEASE CONTROL KEYS.

<L> SWITCHES BETWEEN CONTINUOUS MODE AND SINGLE-STEP MODE.

IN SINGLE-STEP MODE, EACH TIME YOU PRESS A CONTROL KEY THE PEN MOVES (AND DRAWS, IF IN DRAW MODE) A SET DISTANCE, THEN STOPS WITH A BEEP. THIS FACILITY ALLOWS YOU TO MOVE AND DRAW PRECISE DISTANCES WITHOUT GUESSING AND HIT AND MISS.

THE SIZE OF THE SINGLE-STEP IS SELECTED USING THE NUMBER KEYS, 0 TO 9. <0> IS USED FOR NUMBER 10.

FOUR STEP MODE KEYS DETERMINE STEP SIZE SELECTED BY A NUMBER KEY:

<U> IN STEP MODE <U> THE NUMBER KEYS SELECT STEPS OF 1 TO 10.  
<I> IN STEP MODE <I> THE NUMBER KEYS SELECT STEPS OF 11 TO 20.  
<O> IN STEP MODE <O> THE NUMBER KEYS SELECT STEPS OF 21 TO 30.  
<P> IN STEP MODE <P> THE NUMBER KEYS SELECT STEPS OF 31 TO 40.



ONCE YOU SELECT A STEP MODE USING ONE OF THESE FOUR KEYS, HIDRAWER REMAINS IN THAT MODE UNTIL YOU CHANGE IT. YOU CHANGE THE STEP SIZE SIMPLY BY PRESSING A NUMBER KEY, THE SIZE SELECTED BEING IN THE RANGE OF THE CURRENT STEP MODE.

HIDRAWER BEGINS IN STEP MODE U, STEP SIZE 10.

USING STEP MODE AND NUMBER KEYS, YOU HAVE A RANGE OF STEP SIZES FROM 1 TO 40. VERTICAL STEPS ARE LONGER THAN HORIZONTAL STEPS OF THE SAME STEP MODE/NUMBER, DUE TO THE PECULIARITY OF THE VZ'S VIDEO ARCHITECTURE.

<C> WILL DRAW AN OVAL CENTERED ON THE PEN, THE SIZE OF WHICH WILL DEPEND ON THE CURRENT STEP MODE/NUMBER.

<V> DRAWS A 'TSCHIRNHAUSEN'S CUBIC' CURVE, CENTERED ON THE PEN.

DIAGONALS CAN BE PROJECTED FROM THE PEN, THE LENGTHS OF WHICH ARE SET BY THE CURRENT STEP MODE/NUMBER:

- <A> UP LEFT DIAGONAL.
- <D> UP RIGHT DIAGONAL.
- <Z> DOWN RIGHT DIAGONAL.
- <X> DOWN LEFT DIAGONAL.

<SHIFT> <-> WILL WIPE CLEAN THE SCREEN AND RERUN HIDRAWER.

HIDRAWER COULD BE EXTENDED, DEVELOPED FURTHER IN MANY WAYS. BUT I DON'T HAVE THE INCLINATION TO SPEND ANY MORE TIME ON IT. IF YOU DESIGN ANY SUBROUTINE TO ADD TO THE PROGRAM, ANY NEW FACILITIES, SEND THEM TO THE EDITOR OF THE JOURNAL SO HE CAN PUBLISH THEM.

DISK DRIVE OWNERS MIGHT CONSIDER MERGING THE SUITE PROGRAM (SEE ISSUE #20 OF JOURNAL) WITH HIDRAWER SO THAT THEY CAN USE THE IBS FUNCTION OF SUITE TO SAVE THEIR PICTURES ON DISK.

HI-RES DRAWER PROGRAM . . . . .

```

5 ' "HI-RES DRAWER PROGRAM" #21
6 ' ROBERT QUINN JAN. '89
10 GOTO900
18 '
19 ' "IBS"
20 A$=INKEY$:A$=INKEY$
30 COLOR2:SET(A,B):COLOR3:SET(A,B):IF A$="" THEN20
40 IF A$="M" OR A$="," OR A$="." OR A$=" " THEN200
50 X=USR(X):IF A$=":" THEN KP=NOT KP
60 IF A$>"/" AND A$<"": THEN H=VAL(A$):IF H=0 THEN H=10
70 IF A$="C" THEN300 ELSE IF A$="V" THEN350
80 IF A$="N" THEN C=NOT C:COLOR,ABS(C)
90 IF A$="L" THEN G=NOT G ELSE IF A$="=" THEN RUN
110 IF A$="Q" THEN KK=1 ELSE IF A$="W" THEN KK=2
120 IF A$="E" THEN KK=3 ELSE IF A$="R" THEN KK=4
130 IF A$="P" THEN CC=4 ELSE IF A$="O" THEN CC=3
140 IF A$="I" THEN CC=2 ELSE IF A$="U" THEN CC=1
150 IF A$="Z" THEN400 ELSE IF A$="A" THEN450
160 IF A$="D" THEN500 ELSE IF A$="X" THEN550
190 GOTO20
198 '
    
```

```

199 ' "XXXXXXXXXX"
200 IFG<0THENFORR=1TOH+(CC-1)*10
220 COLORCK:SET(A,B)
230 IFAS$="," THENA=A+1:IFA=K1THENA=0
240 IFAS$="M" THENA=A-1:IFA<0THENA=127
250 IFAS$="." THENB=B-1:IFB<0THENB=63
260 IFAS$=" " THENB=B+1:IFB=K2THENB=0
270 IFKP<0THEN290ELSECOLORKK:SET(A,B)
290 CK=POINT(A,B):IFG=0THEN20ELSENEXT:X=USR(X):GOTO20
298 '
299 ' "XXXXXX"
300 COLORKK:B4=H+(CC*3)
310 FORB3=0TO360STEP4:Z=B3/B5:B1=B4*COS(Z)+A
320 B2=B4*SIN(Z)+B:IFINKEY$=" " THENB3=360
330 IFB1<K1ANDB1>KOANDB2<K2ANDB2>KOTHENSET(B1,B2):NEXTELSENEXT
340 SOUND30,2;20,1:GOTO20
348 '
349 ' "XXXXXXXXXX"
350 COLORKK:FORX=-4TO4STEP.05:X4=X*X-K3
355 B1=X4*K3+A:IFB1<0ORB1>=K1THEN380
360 B2=X4*X+B:IFB2<=K0THEN380ELSEIFB2>=K2THENX=4:GOTO380
365 IFINKEY$=" " THENX=4:GOTO380
370 SET(B1,B2)
380 NEXT:SOUND30,2:GOTO20
398 '
399 ' "XXXXXXXXXX"
400 COLORKK:B1=A:B2=B:FORB3=1TOH*CC
410 B1=B1+1:B2=B2+1:IFB1=K1ORB2=K2THENB3=H*CC:GOTO430
420 SET(B1,B2)
430 NEXT:X=USR(X):GOTO20
450 COLORKK:B1=A:B2=B:FORB3=1TOH*CC
460 B1=B1-1:B2=B2-1:IFB1<0ORB2<0THENB3=H*CC:GOTO480
470 SET(B1,B2)
480 NEXT:X=USR(X):GOTO20
500 COLORKK:B1=A:B2=B:FORB3=1TOH*CC
510 B1=B1+1:B2=B2-1:IFB1=K1ORB2<0THENB3=H*CC:GOTO530
520 SET(B1,B2)
530 NEXT:X=USR(X):GOTO20
550 COLORKK:B1=A:B2=B:FORB3=1TOH*CC
560 B1=B1-1:B2=B2+1:IFB1<0ORB2=K2THENB3=H*CC:GOTO580
570 SET(B1,B2)
580 NEXT:X=USR(X):GOTO20
898 '
899 ' "XXXXXXXXXX"
900
910 K2=64:B3=0:C=0:KP=0:K0=-1:K3=3:B4=0:B1=0:B2=0:B5=57
920 COLOR,0:CLS:POKE30862,80:POKE30863,52:MODE(1)
930 B2=0:FORB1=0TO127:SET(B1,B2):NEXT
940 B1=0:FORB2=0TO63:SET(B1,B2):NEXT
950 B1=127:FORB2=0TO63:SET(B1,B2):NEXT
960 B2=63:FORB1=0TO127:SET(B1,B2):NEXT
970 GOTO20

```

DRIVE HEAD PARK ROUTINE  
WRITTEN BY D. MITCHELL

11

HANDS UP THOSE THAT HATE THE NOISES WHICH COME FROM THE DRIVE WHEN THE VZ IS RESET OR POWERED UP. THE REASON FOR THIS NOISE IS THE DOS DOESN'T KNOW WHERE THE DRIVE HEAD WAS LEFT SO IT MUST BE SET TO TRACK ZERO HENCE DOS MOVES THE DRIVE HEAD 40 TIMES.

THIS LITTLE ROUTINE WHICH I CALLED PARK, IS USED IN THE LATEST VERSION WORD PROCESSOR PATCH. IT PLACES THE DRIVE HEAD OF DRIVE 1 AT TRACK 39.

I USE THIS ROUTINE BEFORE I TURN THE POWER OFF, ON THE VZ AND WHEN I SWITCH ON ALL THAT I HEAR IS THE DRIVE HEAD MOVING TO TRACK ZERO WITHOUT THE BASHING THAT WENT ON BEFORE.

THE ROUTINE IS SUPPLIED IN ASSEMBLER FOR THOSE THAT WAY INCLINED OR IN BASIC FOR THE OTHERS.

LISTING FOR BASIC VERSION

```
10 FOR I=29184 TO 29261: READ A :POKEI,A: B=B+A : NEXT
20 IF B <> 9491 THEN PRINT "ERROR IN DATA": END
30 PRINT "INSERT DISK,CLOSE DOOR & PRESS RETURN"
40 AS=INKEY$:IF INKEY$ <> CHR$( 13 ) THEN 40
50 IF PEEK( 16384 ) = 170 THEN 70
60 PRINT "NO DISK DRIVE TO USE" : END
70 BSAVE"PARK",7200,724D
80 END
100 DATA243,205,8,64,62,39,253,150,20,40,4,71,205,22,114,
205,11
110 DATA64,251,195,25,26,253,54,20,39,203,32,253,126,56,79,7
120 DATA245,253,119,56,177,205,63,114,205,54,114,241,205,
63,114
130 DATA205,54,114,16,231,201,197,1,2,0,205,56,64,193,201,230
140 DATA15,79,62,240,253,166,51,177,253,119,51,211,16,201
```

THE ASSEMBLER CODE

```
001 ;DISK HEAD PARK ROUTINE
002 ; ORIGIN 7200 HEX
003 DI
004 CALL 4008H
005 LD A,27H
006 SUB (IY+14H)
007 JR Z,END
008 LD B,A
009 CALL SIN
010 END CALL 400BH
011 EI
012 JP 1A19H
013 SIN LD (IY+14H),27H
014 SLA B
015 SIN1 LD A,(IY+38H)
016 LD C,A
017 RLCA
018 PUSH AF
019 LD (IY+38H),A
020 OR C
```

```

021      CALL  MOVE
022      CALL  DLY
023      POP   AF
024      CALL  MOVE
025      DJNZ  SIN1
026      CALL  DLY
027      RET
028 DLY  PUSH  BC
029      LD   BC,2
030      CALL  4038H
031      POP   BC
032      RET
033 MOVE AND   OFH
034      LD   C,A
035      LD   A,OF0H
036      AND  (IY+33H)
037      OR   C
038      LD   (IY+33H),A
039      OUT  (10H),A
040      RET

```

THIS TIME I AM NOT GOING TO GIVE YOU A BLOW BY BLOW DISCRPTION, IF YOU ARE INTERESTED IN WHAT IS HAPPENING, YOU CAN LOOK UP THE TECHNICAL MANUAL FOR THE DOS ENTRY POINTS.

ALL THAT WE ARE REALLY DOING IS FINDING THE DIFFERENCE BETWEEN THE CURRENT LOCATION OF THE DRIVE HEAD AND TRACK 39 AND MOVING THE HEAD TO TRACK 39. SO WHEN THE VZ IS RESET OR POWERED UP THE DRIVE HEAD MOVES TO TRACK ZERO.

## HINTS & TIPS FOR DISK DRIVE USERS

THE BACK OF MOST DISK JACKETS CONTAIN USEFUL WARNINGS ON AVOIDING PROBLEMS WHICH CAN DAMAGE DISKS OR INFORMATION STORED ON THEM. THERE ARE OTHERS WHICH YOU SHOULD BE AWARE OF :-

**DISK LABELS** - THE ONES SUPPLIED WITH THE DISKS USUALLY STICK LIKE CEMENT AND ARE HARD TO REMOVE WITHOUT DAMAGING DISK. THE SOLUTION IS SIMPLE, USE REMOVABLE LABELS AVAILABLE FROM NEWSAGENTS OR STATIONERS IN VARIETY OF SHAPES AND SIZES.

**MARKING LABELS** - DO NOT USE BIROS, PENCILS OR ANY HARD POINTED WRITING IMPLEMENT. THE DISK ITSELF IS FAIRLY SOFT AND IS EASILY DAMAGED BY PRESSURE. FELT TIP PENS ARE IDEAL FOR THE JOB.

## HINTS & TIPS FOR TAPE USERS . . . .

**TAPE LABELS** - LIKE DISK LABELS THEY ALSO ARE HARD TO REMOVE SO MANY USERS JUST STICK ONE OR MORE LABEL ON TOP OF ANOTHER WHICH CAN CAUSE A PROBLEM. TOO MANY LABELS ON ONE SIDE CAN ACTUALLY LIFT THE CASSETTE UP SLIGHTLY CAUSING MISALIGNEMENT WITH THE HEAD. THE CURE IS SIMPLE, REMOVE OFFENDING LABELS AND REPLACE WITH REMOVEABLE LABELS WHICH ARE AVAILABLE IN A VARIETY OF SIZES.

**SELDOM USED TAPES** - IF YOUR SELDOM USED PROGRAM TAPE REFUSES TO LOAD PROPERLY THEN TRY FAST FORWARD TO END & REWIND TO BEGINNING AGAIN. WHAT HAPPENS IS IF A TAPE IS NOT USED FOR A LONG TIME THE LAYERS OF TAPE TEND TO STICK TOGETHER A BIT AFFECTING PROPER LOADING. FAST FORWARD & REWIND USUALLY CURES PROBLEM.

```

┌───────────────────────────────────────────────────────────────────────────────────┐
│  ─ ERA FILE  ─ REN FILE  ───────────────────────────────────────────────────────────┐
│  ─ LOAD PICT  ─ SAVE PICT  ─────────────────────────────────────────────────────────┐
│  ─ DRIVE [DR] ─ SAVE PROG  ─────────────────────────────────────────────────────────┐
│  ─ DIRECTORY  ─ MEM PEEK  ───────────────────────────────────────────────────────────┐
│  ─ INIT DISK  ─ PICT MENU  ───────────────────────────────────────────────────────────┐
└───────────────────────────────────────────────────────────────────────────────────┘
    
```

```

┌───────────────────────────────────────────────────────────────────────────────────┐
│  PICT MENU  ─────────────────────────────────────────────────────────────────────────┐
│  P/MENU     ─────────────────────────────────────────────────────────────────────────┐
│  PAGEMENU   ─────────────────────────────────────────────────────────────────────────┐
│  PRINT CO   ─────────────────────────────────────────────────────────────────────────┐
│  CODEMENU   ─────────────────────────────────────────────────────────────────────────┐
│  CODENOTE   ─────────────────────────────────────────────────────────────────────────┐
└───────────────────────────────────────────────────────────────────────────────────┘
1-2 DRIVE - 1  C/R-COPY @-SAVE
    
```

```

10 GOTO46
12 ERA"          ":RETURN
14 REN"          ", "          ":RETURN
16 SAVE"         ":RETURN
18 BLOAD"12345678":RETURN
20 BSAVE"12345678",7000,77FF:RETURN
22 BSAVE"12345678",7000,71FF:RETURN
36 :
38 ' " ████████████████████████████████████████████████████████████████████████████

47 CLEAR500:PA=0:DIMP$(140)

50 DF$=" ████████████████████████████████████████████████████████████████████████████ ":HL=1:HL$=""

54 N=N+1:READ P$(N):IF P$(N)<>"*"THEN 54 ELSE P$(N)="":N=N-1

82 CLS:DIR:STATUS

148 :
150 GOSUB 70:PRINT@418," ████████████████████████████████████████████████████████████ ":SOUND 30,1
85 INPUTN$:GOSUB60:AD=31555:GOSUB40
154 MODE(HL):GOSUB 18:SOUND 25,1:GOTO 550
158 :
160 GOSUB 70:PRINT@418," ████████████████████████████████████████████████████████████ ":SOUND 30,1
162 INPUT N$:GOSUB 60:MODE(HL)
164 IF HL=0 THEN AD=31609:GOSUB 40:GOSUB 22:GOTO 168
166 AD=31577:GOSUB 40:GOSUB 20
168 SOUND 25,1:GOTO 550
188 :

300 CLS:POKE30777,1:COLOR3:PRINTS$:RD=237:MD=58
305 PRINT" ████████████████████████████████████████████████████████████████████████████ ":PRINT@MD,HL$:PRINTS$

315 PRINT" ─ LOAD PICT ─ SAVE PICT":PRINT

330 PRINT" ─ INIT DISK ─ PICT MENU":PRINT S$
335 PRINT@MD,HL$:PRINT@418,DF$:GOSUB 390:POKE 30777,35

360 IF D$="L"THEN 150 ELSE IF D$="S"THEN 160 ELSEIFD$="$"THEN 80
365 IF D$="I"THEN 190 ELSE IF D$=":"THEN 405

380 IF D$="-"THEN HL=0+ABS(HL=0):HL$=CHR$(240+HL):GOSUB 392
385 GOTO 350
388 :
390 PRINT@RD,DR$:GOTO 394
392 PRINT@MD,HL$
393 IF HL=1 THEN SOUND 30,2:RETURN:ELSE SOUND 10,2:RETURN
394 DRIVE DR:SOUND0,1:IF DR=1THENSOUND25,1ELSE SOUND25,1;0,1;25,1
396 RETURN
398 :
    
```



THE HI/LO-RES PICTURE COPIER IS A MERGING OF SEVERAL UTILITIES, PAGED MENU (ISSUE # 20), DISK UTILITY (ISSUE # 21), PICTURE COPIER AND SLIDE SHOW. THE PRESENTED AMALGAMATION IS ONLY ONE EXAMPLE ON HOW DISK UTILITY CAN BE USED WITH YOUR OWN PROGRAMS. AND NOW TO THE MODIFICATIONS & ADDITIONS. PAGE 13 SHOWS ALTERATIONS & ADDITIONS TO DISK UTILITY WHILE PAGE 14 HAS ALL THE EXTRA ROUTINES.

DISK UTILITY - REFER TO ISSUE # 21 FOR INSTRUCTIONS IN ITS USE.  
 PAGED MENU - REFER TO ISSUE # 20 FOR INSTRUCTIONS IN ITS USE.

-) MODE(1) - PRESS MINUS (-) KEY TO TOGGLE BETWEEN MODE(1) & MODE(0). THE SCREEN DISPLAY WILL BE UPDATED ACCORDINGLY.

L) - LOAD PICT - ENTER DESIRED FILENAME AND PRESS RETURN.

S) - SAVE PICT - THIS FUNCTION NOT USEABLE AT MOMENT, RESERVED FOR FUTURE USE, A (PICTURE BLOCK MOVE ROUTINE).

:) - PICT MENU - THE COLON (:) IS USED TO TOGGLE BETWEEN MENUES.

; ) - PAGE SWAP - THE SEMI COLON (;) WILL DISPLAY SUCCESSIVE PAGES, ONLY IF THEY CONTAIN FILENAMES. PAGE # WILL BE DISPLAYED ON SCREEN ACCORDINGLY.

1-2 DRIVE - 1 - PRESSING 1 OR 2 WILL SELECT DESIRED DRIVE AND WILL BE ACCOMPANIED WITH ONE BEEB FOR DRIVE 1 & TWO BEEBS FOR DRIVE 2. THE SCREEN DISPLAY WILL BE UPDATED ACCORDINGLY.

/) - SLIDE SHOW - PRESSING SHIFT + K WILL START SLIDE SHOW IN PREVIOUSLY SELECTED MODE AND DRIVE.

C/R-COPY - @-SAVE - Q-QUIT - THESE COMMANDS ARE ONLY AVAILABLE WHEN A HI/LO-RES PICTURE IS DISPLAYED ON SCREEN. 1-2 DRIVE SELECTION IS ALSO AVAILABLE. THE PICTURE CAN BE LOADED FROM EITHER MENU OR DRIVE, BUT NOT FROM SLIDE SHOW.

Q) - QUIT - USE 'Q' TO EXIT AFTER COMPLETION OF SLIDE SHOW, COPY & SAVE OR PICTURE DISPLAY SELECTED FROM EITHER MENU.

C/R-COPY - NOTE - A PRINTER PATCH IS NEEDED FOR THIS OPTION.

THIS OPTION WILL COPY TO PRINTER BOTH MODE(0) & MODE(1) PICTURE SCREENS DEPENDING ON SELECTED MODE.

C) - COPY - IN MODE(1) A HI-RES PICTURE WILL BE COPIED BY PRINTER WITH LEFT MARGIN OF 10.

C) - COPY - IN MODE(0) A LO-RES PICTURE WILL BE COPIED BY PRINTER WITH LEFT MARGIN OF 10.

R) - COPY - IN MODE(0) A LO-RES PICTURE WILL BE COPIED BY PRINTER WITH RIGHT MARGIN OF 43.

R) - COPY - SELECTING 'R' IN MODE(1) IS NOT ALLOWED BECAUSE LEFT MARGIN OF 43 WOULD NOT COPY PICTURE PROPERLY.

THIS COMBINED UTILITY IS BY NO MEANS THE END IN WHAT CAN BE ACHIEVED AS THE PROGRAM CAN BE FURTHER IMPROVED AND ENHANCED IN MANY DIRECTIONS. A PICTURE BLOCK MOVE ROUTINE WHICH WOULD ALLOW USER TO RETAIN PICTURE IN MEMORY AND RECALLED JUST BY A KEYPRESS SHOULD APPEAR IN NEXT ISSUE.

8K SIDEWAYS VIDEO RAM — SUPER GRAPHICS ADAPTOR

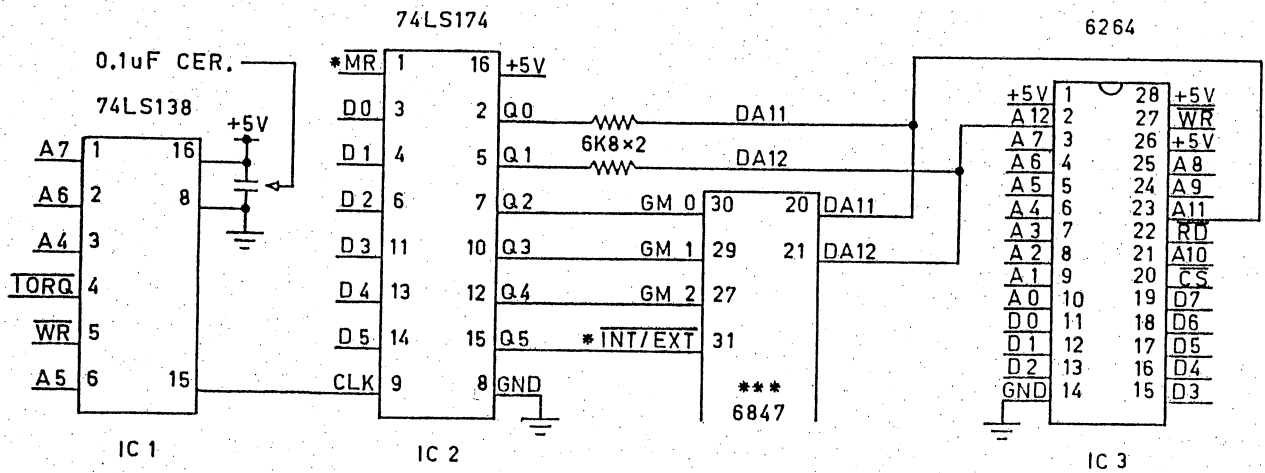

VZ300 VEROBOARD LAYOUT ALL IC'S TOP VIEW 74LS174

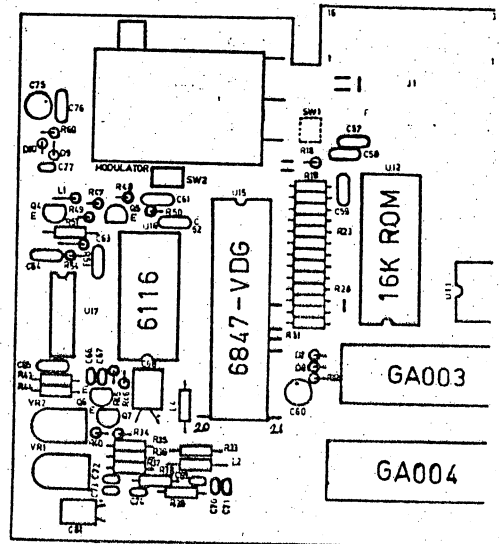
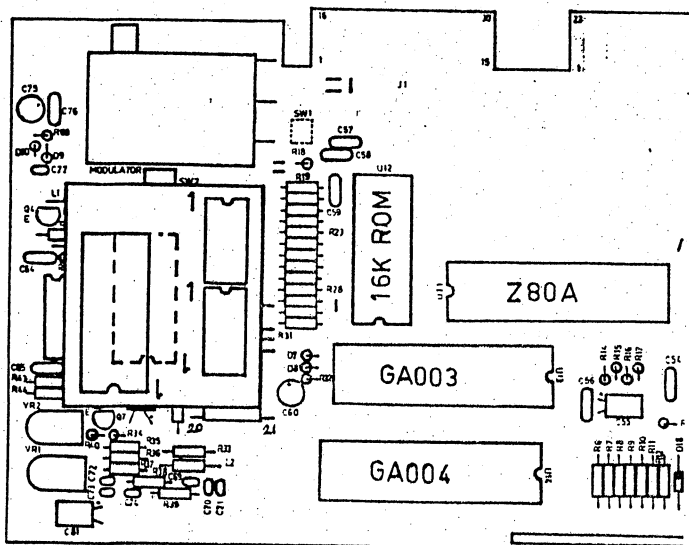
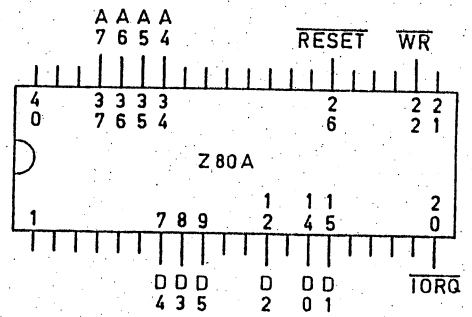
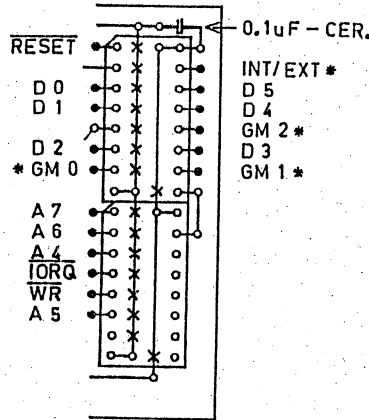
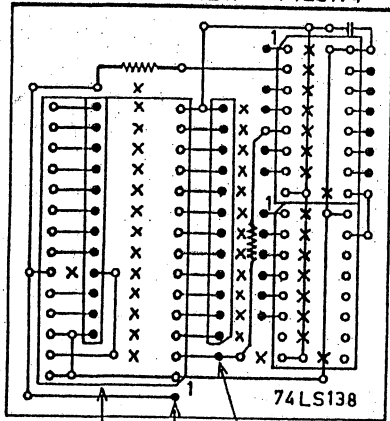



MATTHEW SORELL'S ULTRA GRAPHICS ADAPTOR FOR VZ 200/300 INCREASED THE VZ PALTRY RESOLUTION TO 256 X 192 PIXELS MAXIMUM AND ADDED AN EXTRA 256 NEW CHARACTERS WHICH INCLUDED UPPER/LOWER CASE, GREEK, DATA 70 AND MATHEMATICAL AS WELL AS OTHER SYMBOLS.

BESIDES MATTHEW SORELL, BOB KITCH, CHRIS HOBROUGH AND MYSELF ARE SOME OF THE NAMES THAT SPRING TO MIND WHO HAD VARIOUS DEGREES OF SUCESS IN IMPROVING RESOLUTION ON THE VZ, BUT MATTHEW HAD HIS DESIGN PUBLISHED FIRST AND I FOR ONE CONGRATULATE HIM, WELL DONE.

ONE DRAWBACK WITH THE DESIGN I FELT WAS IT REQUIRED HEAVY MODS TO THE VZ WHICH WOULD RULE OUT MANY WITH INSUFFICIENT EXPIERIENCE FROM ATTEMPTING THE CONVERSION.

MY ORIGINAL AND PRESENT DESIGN DOES NOT INCLUDE EXTRA CHARACTERS, ONLY THE FULL RESOLUTION THE 6847 VIDEO DISPLAY GENERATOR IS CAPABLE OFF. I HAD TO CHANGE MY DESIGN TO MAKE IT COMPATIBLE WITH MATTHEW'S SO ANY SOFTWARE WRITTEN FOR THE HIGHER RESOLUTION WOULD WORK ON BOTH.

I CHOSE A MODULAR DESIGN APPROACH SO PERSONS WITH MUCH LESS EXPIERIENCE SHOULD BE ABLE TO DO THE CONVERSION. ONLY 3 IC'S ARE USED AND THEY ARE MOUNTED ON A PLUG IN MODULE. SO FAR I'VE CONVERTED ONE VZ 200 AND THREE VZ 300'S AND WAS FORTUNATE THEY ALL WORKED AFTER OVERCOMING SOME MINOR MISHAPS AND ONE VZ 300 WHICH HAS LOST ALL COLOUR WHICH I HAVE'NT BEEN ABLE TO FIX.

THE FOLLOWING CONSTRUCTION DETAILS AND VEROBOARD LAYOUT ARE FOR VZ 300 ONLY WHILE THE CIRCUIT DIAGRAM IS SAME FOR BOTH VZ 200/300. VZ 200 VEROBOARD LAYOUT IS COMPLETELY DIFFERENT AND WILL BE GIVEN IN NEXT ISSUE ALONG WITH INSTRUCTIONS FOR USING SUPER GRAPHICS AND SOME PROGRAMS. AND NOW TO THE NITTY GRITTY.

#### CIRCUIT DIAGRAM :-

YOU'LL NOTICE THE CIRCUIT IS VERY SIMILIAR TO MY S/WAYS RAM/ROM PROJECTS AND USES BANK SWITCHING TECHNIQUES, SOME OF WHICH ARE AUTOMATIC WHILE MANUAL SWITCHING CAN BE USED AS WELL AND IS WHERE ALL THE FUN COMES IN.

IC 1 - THIS IC DECODER IS USED AS A 16 BIT ADDRESS DECODER IN THE RANGE A32-A47 WHICH IS USED TO TRIGGER IC 2, A 6 BIT LATCH.

IC 2 - THIS 6 BIT LATCH (Q0 TO Q5) HAS TWO FUNCTIONS TO PERFORM.

- 1) - USING BITS 0 & 1 BANK SWITCH IC 3, AN 8K VIDEO RAM.
- 2) - USING BITS 2 - 4 SELECT GRAPHICS MODE 0 - 7 ON VDG 6847.

NOTE - BIT 5 NOT REALLY NECESSARY, BUT IS INCLUDED FOR INTEREST.

IC 3 - THE 6264, AN 8K RAM REPLACES THE 2K VIDEO RAM.

VDG - THE 6847, A VIDEO DISPLAY GENERATOR CHIP CAN ADDRESS UP TO 8K VIA IT'S 13 ADDRESS LINES, BUT IN CASE OF THE VZ ONLY ADDRESSES 2K. TO GET THE MAXIMUM RESOLUTION OF 256 X 192, 6K OF VIDEO MEMORY IS REQUIRED. AS THERE'S NO SUCH THING AS A 6K RAM, AN 8K RAM IS USED WHICH LEAVES US WITH A SPARE 2K FOR OTHER USES.

NOTE - IC 1, 2 & 3, TWO RESISTORS AND ONE DECOUPLING CAPACITOR ARE MOUNTED ON THE PLUG IN MODULE WHICH PLUGS INTO VACATED 2K VIDEO RAM POSITION THEREBY SAVING OVER 30 CONNECTIONS.

PREPARING VZ 300 - FIRST TAKE VZ CASE APART AND REMOVE CIRCUIT BOARD FROM CASE. NEXT REMOVE RF SHIELD BY UNSOLDERING IT FROM PCB.

6116 - UNSOLDER 2K VIDEO RAM OR CUT PINS ON ONE SIDE AND LEVER BACK AND FORTH TILL PINS BREAK ON OTHER SIDE. REMOVE PIN STUBS AND INSPECT BOARD FOR DAMAGE. NEXT SOLDER A 24 PIN M/I SOCKET IN 6116'S PLACE.

6847 - THERE'S NO NEED TO REMOVE THIS IC UNLESS YOU'RE CONFIDENT. USING SMALL SIDECUTTERS CUT THE FOLLOWING PINS AS CLOSE TO THE PCB AS POSSIBLE AND BEND UP 90 DEG. CUT PINS 20, 21, 27, 29 & 30 ON 6847. PIN 31 (INT/EXT) SERVES NO USEFUL FUNCTION IN THIS DESIGN AS IT'S USED FOR EXTERNAL CHARACTER SET WHICH THIS DESIGN DOES NOT INCORPORATE.

Z80A - TAKE THE LID OF 40 PIN IDC DIL PLUG AND STICK LABEL ON TOP SIDE AND MARKING PINS WHICH WILL TAKE CONNECTIONS AND THEN SOLDER ON TOP OF Z80A MAKING SURE YOU HAVE NO SOLDER BRIDGES BETWEEN PINS.

PREPARING PLUG IN MODULE :-

VEROBOARD - THE TRACKS RUN HORIZONTALLY, FROM LEFT TO RIGHT. OPEN AND SOLID CIRCLES DENOTE USED HOLES ON VEROBOARD. VERTICAL LINES DENOTE INSULATED LINK WIRES. HORIZONTAL LINES SIMPLY DENOTE USED TRACKS AND ARE SHOWN FOR CLARITY ONLY. THE (X'S) DENOTE CUT TRACKS.

USING AN 1/8" (3MM) DRILL BIT CUT TRACKS MARKED WITH AN (X) CHECKING AND DOUBLE CHECKING ALL ARE CORRECT AND HAVE'NT MISSED ANY. NEXT INSERT ALL LINK WIRES. PLEASE NOTE LINK WIRES UNDER 74LS174, PIN 8 & 74LS138 PIN 16 HAVE TWO WIRE LINK ENDS GOING INTO SAME HOLE. MOUNT TWO RESISTORS AND CAPACITOR NEXT.

M/I ADAPTOR STRIP - THIS IS A DOUBLE SIDED SINGLE ROW OF PINS WHICH CAN BE SNAPPED TO DESIRED LENGTH. ONE SIDE HAS THINNER PINS THAN OTHER SIDE. SNAP TWO LENGTHS OF 12 PINS EACH. INSERT THE STRIPS IN THE 24 PIN RAM SOCKET WITH THINNER PINS AT BOTTOM.

NEXT PUT VEROBOARD ON TOP OF PINS AND LOWER DOWN ON THEM. LIFT V/BOARD UP TILL IT JUST CLEARS COMPONENTS AND MARK HEIGHT ON PINS. REMOVE PINS FROM SOCKET AND SOLDER THICK PINS TO V/BOARD TO MARKED HEIGHT AND CUT PINS FLUSH WITH TOP OF V/BOARD. THE TWO STRIPS ON V/BOARD LAYOUT MARKED WITH SOLID CIRCLES IS WHERE THE STRIPS ARE SOLDERED TO.

USING NO SOCKETS SOLDER THE 74LS174, 74LS138 & 6264 IC'S IN NEXT. USING THE V/BOARD CUTAWAY AS A GUIDE SOLDER ALL 19 OFF BOARD LINK WIRES. USING BIT OF THIN CARDBOARD LIKE FROM BACK OF WRITING PAD CUT A PIECE BIT LARGER THAN V/BOARD. CUT TWO SLOTS FOR THE TWO STRIPS TO GO THROUGH AND INSERT C/BOARD UNDER BOARD WHICH IS USED TO INSULATE BOTTOM OF V/BOARD FROM COMPONENTS IN VZ.

PLUG IN MODULE IN VACANT 24 PIN SOCKET AND SOLDER THE 5/6 WIRES TO 6847 FIRST WHICH ARE DENOTED BY ASTERICKS. NEXT ONE BY ONE CONNECT REMAINING WIRES TO Z80A. USING VZ PCB LAYOUT AS A GUIDE TAKE WIRES AROUND BOTTOM, NOT ACROSS 16K ROM IN CASE THE ROM HAS TO BE REPLACED AT A LATER STAGE. PRESS THE WIRES INTO SLOTS ON THE IDC DIL PLUG AND CUT OFF EXCESS. THIS APPROACH SAVES A LOT OF SOLDERING AND IN CASE OF WIRING ERRORS ARE SIMPLY RECTIFIED.

TESTING - POWER UP THE VZ AND IF DISPLAY NORMAL TYPE IN OUT 32,9 AND PRESS RETURN. PRESSING ANY KEY WILL PRODUCE A NORMAL BEEB BUT NOTHING WILL BE HAPPENING ON THE SCREEN WHICH IS NORMAL. TO GET BACK TO NORMAL RESET VZ OR TYPE IN CAREFULLY OUT 32,8 AND PRESS RETURN WHICH WILL RESTORE VZ TO NORMAL.

WHENEVER YOU POWER UP OR RESET THE VZ TYPE IN OUT 32,8 AND PRESS RETURN. IT'S A GOOD IDEA TO INCLUDE AN OUT 32,8 AT START IN ALL YOUR PROGRAMS. TO TEST SUPER GRAPHICS AND BANK SWITCHING TRY THE FOLLOWING :-

RUN OR BRUN A HI-RES GAME THREE TIMES USING FOLLOWING SYNTAX :-

OUT32,24:MODE(1):RUN"YOURGAME" AND PRESS RETURN  
OUT32,25:MODE(1):RUN"YOURGAME" AND PRESS RETURN  
OUT32,26:MODE(1):RUN"YOURGAME" AND PRESS RETURN

THE GAME WILL LOAD AND RUN IN TURN USING PAGE 0, TOP THIRD, PAGE 1, MIDDLE THIRD & PAGE 2, BOTTOM THIRD OF SCREEN. WHAT WE ARE DOING IS SELECTING GRAPHICS MODE(6) AND PAGE 0, PAGE 1 AND PAGE 2. EACH PAGE CONSISTS OF 128 X 64 PIXELS AND WHEN WE ADD THEM TOGETHER WE GET 128 X 192 PIXELS. MORE DETAILED INSTRUCTIONS AND EXPLANATION IN NEXT ISSUE.

---

## VZ USER GROUPS & PUBLICATIONS

---

VZ USER - NO WORD AS YET IF ANYONE IS TAKING OVER ITS PUBLICATION

LE'VZ OOP - VZ MAGAZINE - VSOFTWAREZ/SOFTWARE/HARDWARE FOR SALE  
J.C.E. D'ALTON 39 AGNES ST. TOOWONG QUEENSLAND 4066

VZ DOWN UNDER - VZ MAGAZINE - 6 ISSUES - \$18.00 PER YEAR  
HARRY HUGGINS 12 THOMAS ST. MITCHAM 3132 VICTORIA

VZ-LINK - PETER J. HILL P.O.BOX 1972 C.P.O. AUCKLAND N.Z.

WAVZ - GRAEME BYWATER P.O. BOX 388, MORLEY W.A. 6062

BRISBANE VZ USERS WORKSHOP - C/O 63 TINGALPA ST. WYNUM WEST 4178  
SOFTWARE FOR SALE - DISK MENU

---

HUNTER VALLEY VZ USERS' GROUP - P.O. BOX 161 JESMOND N.S.W. 2299  
SECRETARY/EDITOR-JOE LEON (049) 51 2756  
PRESIDENT-ROSS WOODS (049) 71 2843  
TREASURER - MATTHEW TAYLOR -\*\*\*- COMMITTEE MEMBER - COLIN BRIDGE

SUBSCRIPTION - H.V.VZ.JOURNAL - 6 MONTHS \$9.00 - 12 MONTHS \$18.00  
NEW ZEALAND - 6 MONTHS \$12.00 - 12 MONTHS \$24.00

MEETINGS - FIRST FRIDAY OF MONTH AT JESMOND NEIGHBOURHOOD CENTRE  
MORDUE PARADE - REAR STOCKLAND MALL (BIG W) JESMOND

NOTE :- WHEN WRITING TO ANY ABOVE OR H.V.VZ. USERS' GROUP FOR  
INFORMATION PLEASE ENCLOSE A S.S.A.E. OR NZ 2 INT. REPLY COUPONS.

---

VZ SCREEN ED - \$25.00 + \$2.00 POST & HANDLING.

VZ SCREEN ED IS A NEW DRAWING PROGRAM FOR HI-RES SCREENS WITH  
MANY POWERFUL OPTIONS. BOTH TAPE AND DISK USERS ARE CATERED FOR.

SEND YOUR CHEQUE OR MONEY ORDER TO :-  
MATTHEW TAYLOR SOFTWARE -- OR PHONE (049) 75 2350  
38 FISHING POINT ROAD RATHMINES NSW 2283 AUSTRALIA

YOU CAN SEE MATTHEW AT CLUB MEETINGS FOR A DEMONSTRATION OR  
PURCHASE OF SCREEN ED.

**\*\*\* NEW \*\*\*\* FOR SALE \*\*\*\* NEW \*\*\* 20**

## **E & F WORD PROCESSOR PATCH 3.3**

THIS LATEST PATCH WRITTEN BY DAVE MITCHELL WILL CONVERT YOUR E & F TAPE WORD PROCESSOR FOR FULL DISK USE WHILE RETAINING ALL TAPE FUNCTIONS. BELOW ARE THE DISK COMMANDS & ADDED FUNCTIONS :-

**LOAD, SAVE, ERASE, RENAME, DIRECTORY, INITIALIZE, UPDATE, DRIVE 1 & 2, SHIFTLOCK & IMBEDDED PRINTER CONTROL CODES**

PATCH 3.3 HAS PROVISION FOR IMBEDDING PRINTER CONTROL CODES IN TEXT AND FAST SAVING AND LOADING OF TEXT DATA TO AND FROM DISK USING BLOCK SAVE/LOAD TECHNIQUES.

MINIMUM MEMORY REQUIREMENTS :-  
VZ 300 + 16K RAM PACK - VZ 200 + 26K

**PATCH 3.3 IS COPYRIGHT TO AND ONLY AVAILABLE FROM :-  
HUNTER VALLEY VZ USERS' GROUP P.O. BOX 161 JESMOND 2299  
N.S.W. AUSTRALIA - Phone (049) 51 2756**

PRICE - AUS/NZ AU\$20.00 - UPDATE - AUS-\$10.00 - NZ-AU\$11.00.  
UPDATING AVAILABLE ONLY TO PREVIOUS PURCHASERS OF OUR PATCHES.

**FOR MORE INFORMATION WRITE TO H.V.VZ.U.G. ENCLOSING A SSAE.**

## **FOR PRIVATE SALE**

**EXTENDED DOS V1.3 - \$15.00**

THE PREVIOUS VERSION HAS BEEN UPDATED WITH EXTRA COMMANDS ADDED.

OLD COMMANDS - MERGE, DIRA, LDIRA, DIRB, LDIRB, OLD, OLD., DEC, HEX, STATUSA AND LSTATUSA. STATUSA AND LSTATUSA ALSO WORKS WITH VERSION 1.0 DOS.

NEW COMMANDS :-

MENU - LOADS AND RUNS BINARY OR TEXT MENU PROGRAM FROM DISK.  
CODE - SIMPLIFIES USING PRINTER CONTROL CODES DIRECTLY OR FROM WITHIN A PROGRAM.  
LTAB - IS FOR SETTING OF LEFT MARGIN.  
MOVE - MOVES BASIC FILE FROM DISK TO CHOSEN MEMORY ADDRESS.  
UPD - ERASES OLD FILE AND SAVES WITH SAME FILE NAME.

**MENU/FILE COPIER/DISK ORGANIZER - \$15.00**

THIS UTILITY WILL READ YOUR DISK DIRECTORY AND PRESENT YOU WITH SEVERAL OPTIONS. USING THE CURSOR YOU CAN RUN/BRUN ANY PROGRAM OR SELECT FILE COPY, REN, ERASE, DRIVE 1 OR 2, ETC. BESIDES COPYING TEXT AND BINARY FILES ALL OTHER FILES CAN BE COPIED AS WELL EXCEPT FOR DATA FILES.

**FOR PURCHASE OR INFO CONTACT - DAVE MITCHELL - (079) 27 8519  
24 ELPHINSTONE St. NORTH ROCKHAMPTON QUEENSLAND 4701**

FOR INFORMATION OR DEMONSTRATION IN NEWCASTLE AREA CONTACT :-  
JOE LEON - (049) 51 2756 - 22 DRURY ST. WALLSEND NSW 2287

SUPER GRAPHICS - ISSUE # 22 PAGES 16-19

THE PARTS LIST FOR SUPER GRAPHICS WAS ACCIDENTALLY LEFT OUT.



1 X 74LS138                      1 X 74LS174  
1 X 6264 8K RAM                2 X 6K8 RESISTORS  
1 X 0.1 OR 0.1 CERAMIC OR MONOLITHIC CAPACITOR  
1 X 24 PIN M/I (MACHINE INSERT) SOCKET  
1 X 32 PIN M/I ADAPTOR STRIP  
1 X 40 WAY IDC FLAT RIBBON CABLE DIL PLUG  
19 X 15CM (6") LENGTHS OF INSULATED HOOK UP WIRE  
1 PIECE OF VEROBOARD 17 HOLES ACCROSS BY 19 TRACKS DOWN.

